

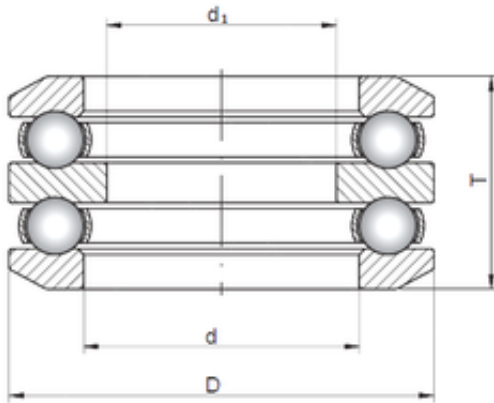

CAR Bearing manufacturing Co.,Ltd

ISO 54207 thrust ball bearings



Bearing No. 54207

Size	37x62x37.8 mm
Bore Diameter	37 mm
Outer Diameter	62 mm
Width	37,8 mm
d	37 mm
d1	30 mm
D	62 mm
T	37,8 mm

54207 Bearing 2D drawings and 3D CAD models