

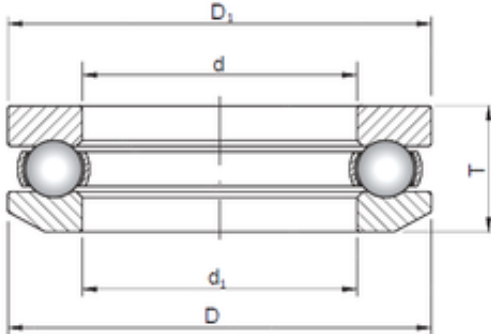

CAR Bearing manufacturing Co.,Ltd

ISO 53406 thrust ball bearings



Bearing No. 53406

Bore Diameter	30 mm
Outer Diameter	70 mm
d	30 mm
d1	32 mm
D	70 mm
D1	70 mm
T	30,1 mm

53406 Bearing 2D drawings and 3D CAD models